

DC Under-bench Air Conditioner



Instruction Manual

Table of Contents

1.IMPORTANT SAFETY INFORMATION	3
1.1 Understand Signal Words.....	3
1.2 General Safety Message	3
2.SPECIFICATIONS	4
3.ACCESSORIES	5
4.INSTALLATION.....	6
4.1 Exhaust Vent	7
4.2 Drain Line.....	12
4.3 Unit	13
4.4 Air Duct (Optional).....	14
4.5 External Control Panel (Optional).....	14
4.6 Test Run.....	15
5.OPERATION	16
5.1 Modes.....	16
5.2 External Control Panel	16
5.3 Internal Control Panel	17
5.4 Remote Control	18
5.5 Switch Display Unit °C/°F.....	19
5.6 Under/Over-Voltage Protection.....	19
5.7 Edit Low Voltage Protection.....	19
6.TROUBLESHOOTING	20
6.1 Error code.....	20
6.2 Unit not cooling.....	21

1.IMPORTANT SAFETY INFORMATION

This manual has safety information to help users eliminate or mitigate the risk of accidents and injuries.

The installation of this unit MUST comply with the following code:

U.S: NFPA1192, NFPA70

CANADA: C22.1, CSA Z240

1.1 Understand Signal Words

⚠ WARNING

Indicates a hazardous situation that if NOT avoided, could result in death or serious injury.

⚠ CAUTION

Indicates a hazardous situation that if NOT avoided, could result in minor or moderate injury.

NOTICE

Indicates practices NOT related to physical injury

1.2 General Safety Message

⚠ WARNING

- This unit MUST be installed and repaired by qualified personnel who are familiar with the risks involved.
- Do NOT modify this product in any way. Any modifications can be extremely hazardous.
- Keep electrical devices out of reach of children and do not allow them to operate the device without supervision.
- Only use accessories authorized by Velit.
- Do NOT use this unit in or near flammable environment.
- Do NOT let children use the unit without supervision

NOTICE

- Do NOT use this unit when the ambient temperature is lower than 40°F. This could cause frost inside the unit.
- Do NOT power wash the unit or use detergent to clean the unit.

2.SPECIFICATIONS

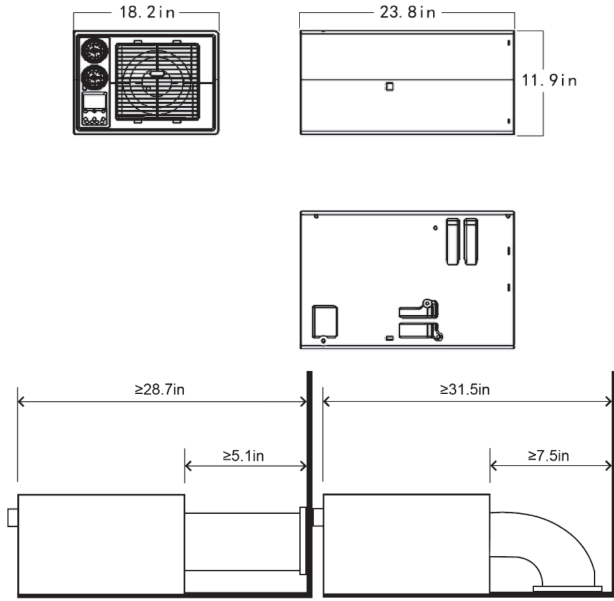

Input Voltage	12V	24V	48V
Operating Current	20-60A	10-33A	5-15A
Cooling Capacity	8000BTU/2200W		
Air Flow Rate	400mc/h		
Rated Power	700W		
Refrigerant	R134a 400g		
Noise Level	Eco mode: 50dB Boost mode: 60dB		
Dimension	23.8" L x 16.2" W x 11.8" H		
Weight	36.4lb		

3.ACCESSORIES

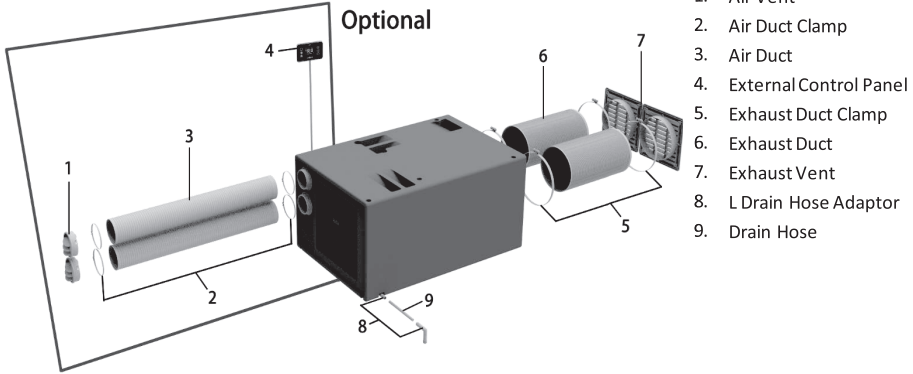

1. Air Vent
2. Air Duct Clamp
3. Air Duct
4. External Control Panel
5. Exhaust Duct Clamp
6. Exhaust Duct
7. Exhaust Vent
8. L Drain Hose Adaptor
9. Drain Hose

Parts	Quantity
Corner Bracket with Screws	6
100mm Exhaust Duct (4ft)	2
Exhaust Vent	2
Exhaust Duct Clamp	2
Duct mounting plate	2
64mm Air Duct (6ft)	2
Air Vent	2
Air Duct Clamp	2
External Control Panel with 6ft wiring	1
Drain Hose (1.5ft)	1
L Drain Hose Adaptor	2
Remote	1
Wiring Harness (6ft)	1
Cutting template set	1

4.INSTALLATION

⚠ CAUTION

When drilling into the vehicle body, make sure to check the other side and avoid drilling into other components/wiring. Always apply sealant/paint to bare metal around the cut surface to prevent rust.

⚠ WARNING

Make sure to disconnect all power supplies to the vehicle including battery, generator, and shore power prior to installation.

NOTICE

The installation procedure can be complicated. Please read the ENTIRE installation section before starting to ensure the smoothest installation process. The general process should follow the order below. Failure to do so can result time-consuming re-work.

1. Identify unit location and exhaust vent location
2. Drill holes for exhaust vents
3. Install exhaust vents
4. Identify drain hole location and drill the drain hole
5. Pull out extension connector for the external control panel (optional)
6. Secure the unit
7. Connect exhaust ducts
8. Connect drain hose
9. Install air vent and connect duct (optional)
10. Install external control panel (optional)
11. Connect power
12. Test air flow

4.1 Exhaust Vent

Locate the exhaust vent location using the cutting template. Three configurations are available to choose from:

One Rectangular hole

Exhaust and intake vents can be mounted together using the metal plate and six screws. For this configuration, a rectangular hole needs to be cut. This approach is easier and faster for installation.

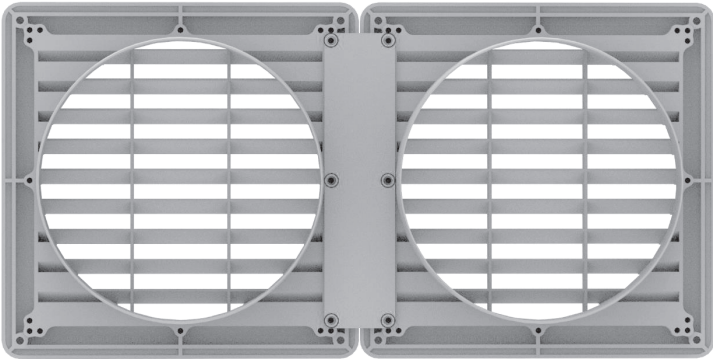

Two square holes

The intake and exhaust vents are mounted separately. Two square holes need to be cut. This configuration offers the most flexibility.

The vents can be mounted on the wall or on the floor. Follow the instruction below for mounting in different locations.

Two round holes

Cut two 6-inch round holes at least 2 inches apart edge to edge. This works the best on flat and even surfaces.

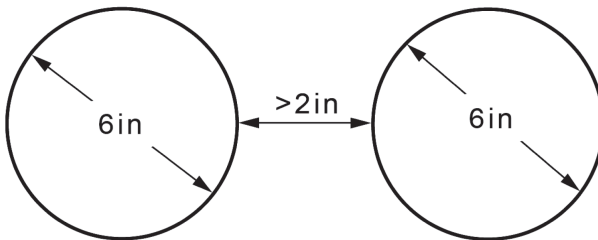

Vent through the floor:

- Leave enough room for the vent and the unit.

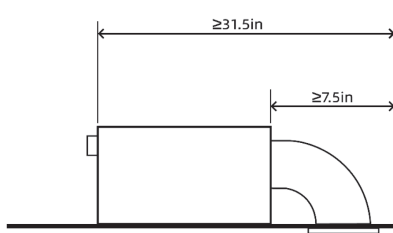

- Make sure the vent location has free airflow and is free of direct obstruction within 8 inches.

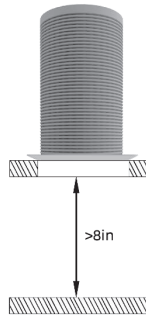

- Make sure the fins on the vents do not point at each other.



- Cut the hole using the template. Apply sealant/paint to any bare metal edges.

- Place the vent over the opening. Secure the vent to the floor with four self-tapping screws.

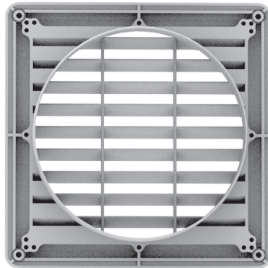
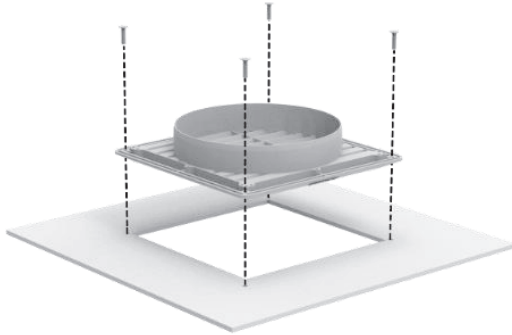

- Apply sealant to the edge of the vent if needed.

Vent through the wall

- Leave enough room for the vent and the unit.

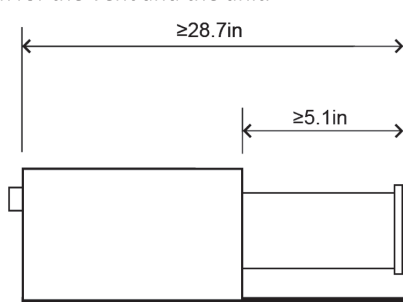

- Follow the UP icon, the vents must be installed as shown.

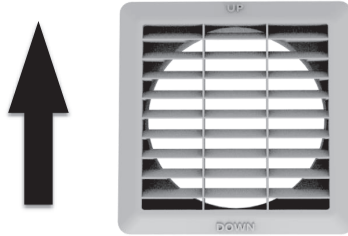

- Make sure the vent location has free airflow and is free of direct obstruction within 8 inches.

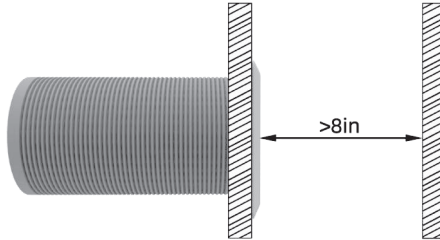

- Cut the opening using the template. Apply sealant/paint to any bare metal edges.
- Connect one end of the duct to the vent. Tighten the clamp and pass the duct through the opening.

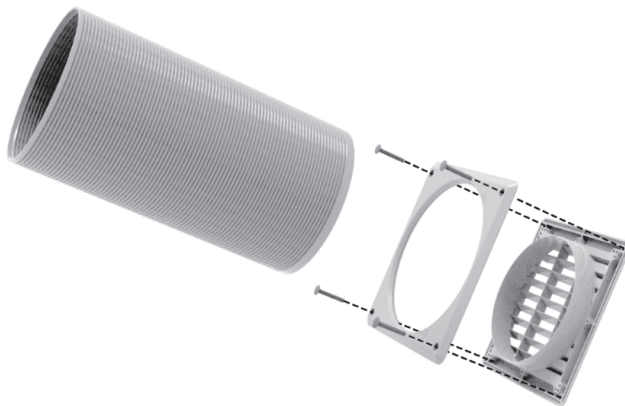

- Apply sealant along the edge of the vent and press it over the opening.

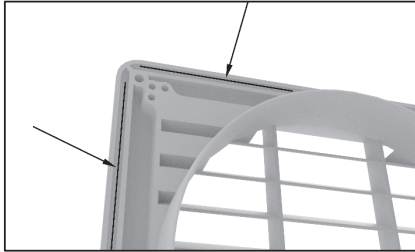

- On the inside, place the trim over the opening. Use self-tapping screws to secure the inside vent piece to the outside vent piece.

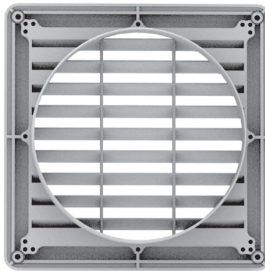

- Connect the ducts to the unit. Use hose clamp to secure the duct

- Use the foam block to jack up the duct to form a slight slope. This prevents moisture from accumulating in the duct.

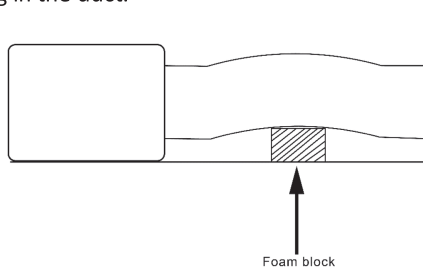

4.2 Drain Line

- The drain hose can be installed to exit the unit from either the front or the side.
- Insert the L hose adaptor into the drain outlet in the desired position.

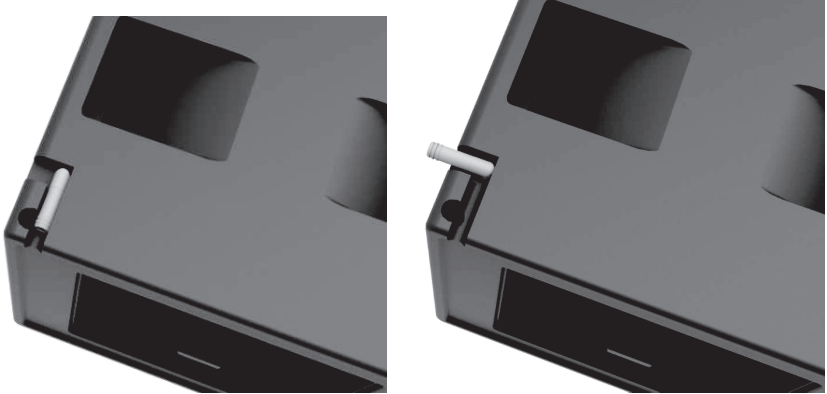

- If the drain outlet exits the front of the unit, connect the drain line to the outlet before securing the unit to the floor because the outlet will not be accessible once the unit is secured in place.
- Drill a ½ inch (12mm) hole on the floor within 1.5ft of the drain outlet.
- Wrap double-sided tape (comes with the unit) around one end of the other L-shape hose adaptor. Insert the hose adaptor into the drain hole. Trim the drain line to proper length and connect the drain line from the unit to the hose adaptor.

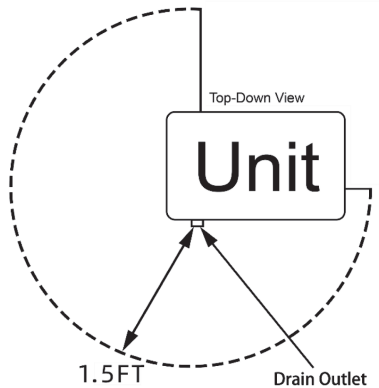

4.3 Unit

NOTICE

The unit location needs to have proper airflow with the interior space. If the unit is installed inside of a cabinet, a 5" x 5" or similar size vent hole may need to be cut if insufficient air flow is noticed during the test run section later.

- Use the template to locate the install location.
- Secure the unit with corner brackets: two on each side and one in the front and back. If one side is against the wall, no brackets are needed for that side.
- Refer to the drain hose section, install the L drain hose adapter in the preference orientation (front or side).
- Put the unit in place and use screws to secure the corner brackets to the floor. If the screws tap into metal through to the exterior, apply sealant/ paint on the underside at the protrusions.
- Drill screws through the corner brackets into the side of the unit. **Do NOT over-tighten.**



4.4 Air Duct (Optional)

Air vents can be directly mounted on the unit or ducts can be attached to distribute the cool air to different areas. If using the included ducts, drill 2.5-inch holes to install the vents in the desired location.

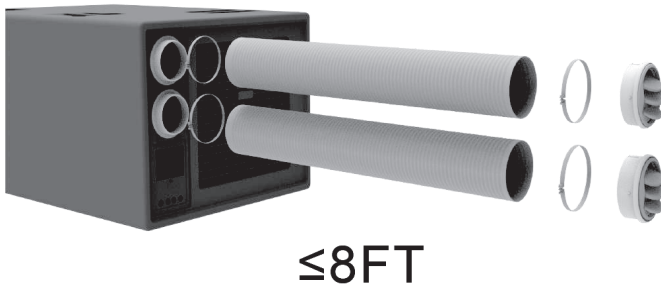

4.5 External Control Panel (Optional)

The external control panel can be connected for easier access and better remote reception.

- Pull out the extension connector out from the bottom of the unit (right underneath the internal display panel).
- Mount the control panel case to the wall with four screws.
- Drill a hole in the center and pull the wiring through.
- Clip the control panel to the case.
- Connect the wiring to the unit.

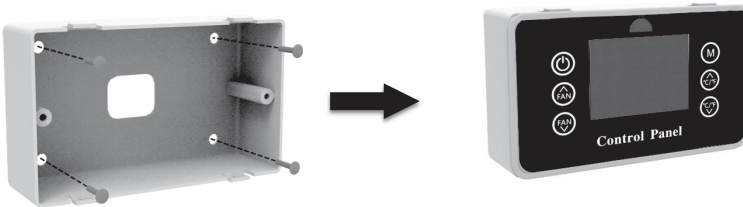

4.6 Test Run

- Leave the access panel/ cabinet door open.
- Turn on the unit and set the fan speed to max.
- Listen to the sound/ pitch of the blower fan and feel the air volume.
- Close the access panel/ cabinet door.
- Make sure there is no obvious change in blower fan sound/ pitch and air volume.
- If there is a noticeable change, a 5" x 5" or similar size vent hole needs to be cut near the unit to allow sufficient airflow.

5. OPERATION

5.1 Modes

Mode changes only change the compressor speed. Fan speed can be adjusted separately. Output from low to high:



5.2 External Control Panel

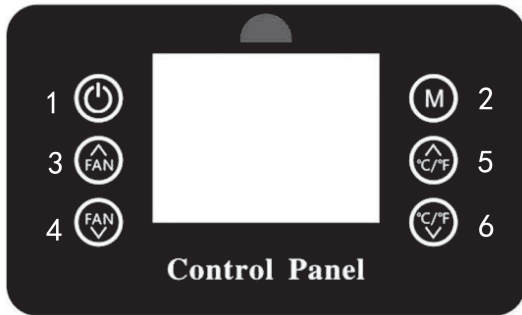

1 - Power ON/OFF: short press to turn on the unit. Long press for two seconds to turn off the unit. Long press ten seconds to reset to factory default setting.

2 - Mode Switch: short press to switch between operating modes:

Output from low to high output: Sleep, Eco, Cooling, Turbo

The mode only changes compressor speed. Fan speed can be adjusted separately.

3 - Fan Speed +: Increase fan speed

4 - Fan Speed -: Decrease fan speed

5 - Temperature +: Increase setting temperature

6 - Temperature -: Decrease setting temperature

5.3 Internal Control Panel

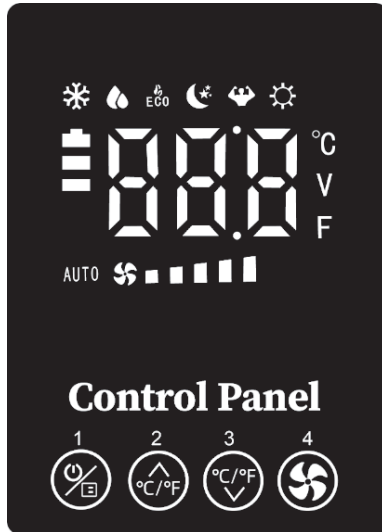

1 – Power/Mode: short press to turn on the unit. When unit is on, short press to cycle through modes. Long press two seconds to turn off the unit. Long press ten seconds to reset to factory default setting.















2 - Temperature +: Increase setting temperature

3 - Temperature -: Decrease setting temperature

4 - Fan Speed: Cycle through 5 fan speeds

5.4 Remote Control

NOTICE This is a general-purpose remote. Some buttons do not apply to this model.

-  : Turn ON/OFF
-  : Switch between modes
-  : Change fan speed
-  : Increase temp
-  : Decrease temp
-  : Sleep mode
- ECO** : ECO mode
-  : Cooling mode
-  : Turbo mode
-  : View voltage
-  : Timer
-  : Heating mode
-  : N/A
-  : N/A
-  : N/A
-  : N/A

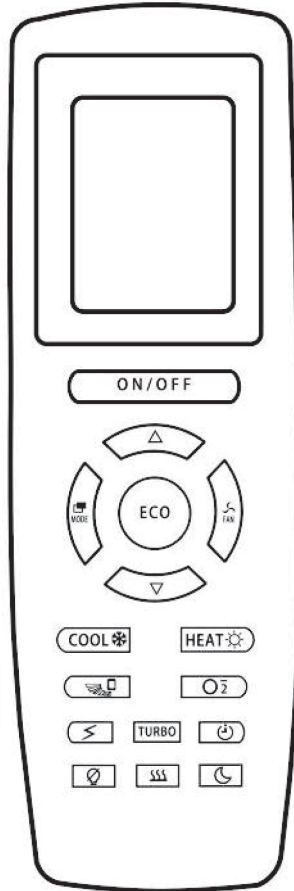

5.5 Switch Display Unit °C/°F

This feature is only available to units that come with display remote control. When the unit is powered off, on the remote control, short press the mode button and down arrow button at the same time. The display unit on the remote will switch. Turn the unit on with the remote and the unit on the display panel will sync with the remote.

5.6 Under/Over-Voltage Protection

Low voltage protection will auto shut off the unit when the supplied voltage is lower than the cut-off voltage (default 10.5/21.5V) and the low-voltage red light will light up. The unit will turn on automatically once the supplied voltage is higher than the recover voltage (default 12/23V).

When the supplied voltage is higher than 15/30V, the unit will turn off and the high-voltage red light will light up. The unit will turn on automatically once the supplied voltage is lower than 18/30V.

5.7 Edit Low Voltage Protection

Long press the Mode Switch to edit low voltage protection. Press Fan Speed + to increase cut-off voltage. Press Fan Speed - to decrease cut-off voltage. Press Temperature + to increase recover voltage. Press Temperature - to decrease recover voltage.

6.TROUBLESHOOTING

6.1 Error code

There are multiple sensors built inside the unit. When an error is detected, the error icon will flash with the error code displayed. Check the table below for the meaning of the error codes and contact customer service when needed.

Code	Cause	Troubleshooting
E0	Ambient temperature sensor (White 2 pin connector)	Use a flathead screw driver to pry open the display panel. Ensure the white 2pin connector is seated properly. Replace the sensor or the display panel if needed
E1	Evaporator temperature sensor (Red 2 pin connector)	E1: Use a flathead screw driver to pry open the display panel. Ensure the red 2pin connector is seated properly. Replace the sensor or the display panel if needed.
E2	Over-current	Verify there is no short in the wiring harness. Make sure the outside fan and the side/bottom air inlet are not blocked. Rinse the condenser with water to clean off elements.
E3	Blocked rotor	Contact customer service
E4/EL	Low-voltage	Check the system and battery voltage. By default, this error code triggers when voltage drops below 10.5V/21.5V. Make sure the wiring is connected properly and there is no loose nuts or crimps
E5	Short protection/faulty controller	Contact customer service
E6/EH	Over-voltage	Check the system voltage. It should be less than 15V/30V
E7	Compressor startup failure	Contact customer service
E8	Condenser fan	Make sure condenser fan connector is seated properly.
EF	Evaporator blower fan	Make sure the blower fan connector is seated properly. Pry open the display panel and make sure the fuse is intact.
Eb	Controller lack-phase	Contact customer service
EU	Controller overheated	Let the unit sit for ten minutes and restart the unit

6.2 Unit not cooling

Turn on the unit and use a pressure gauge to measure the pressure at the low-pressure port. Use this chart to find the nominal pressure value based on the ambient temperature. If the pressure is lower than the nominal value, use a R134a recharge kit (can be purchased from Auto part stores and Home Depot) to charge the unit to the desired pressure. If there is oil or other signs of a refrigerant leakage, reach out to a mechanic or RV technician to identify and fix the leak. Vacuum the system and charge with 400g of R134a.

Ambient (Outside) Temperature °F	Standard Low Side Pressure Range PSI
65	25-35
70	35-40
75	35-45
80	40-50
85	45-55
90	45-55
95	50-55

